

N Connectors for HELIAX® LDF7-50A Coaxial Cable

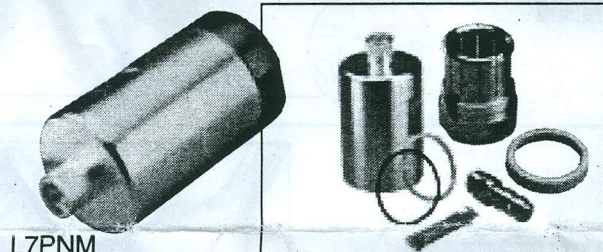

L7PNM
L7PNM-H

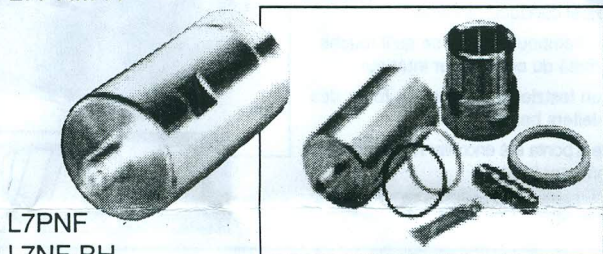

L7PNF
L7NF-BH

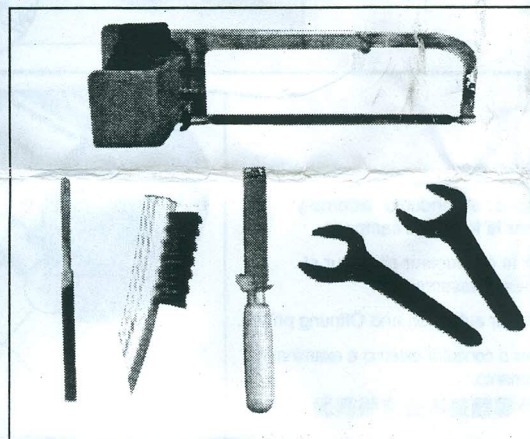

FAX-On-Demand: +1-708-873-3614 • North America: 1-800-861-1700

Tips and Techniques (SP50047) available by FAX-On-Demand.
Los consejos prácticos y técnicas (SP50047) pueden solicitarse por fax.

Conseils et techniques (SP50047) disponibles par fax à la demande.
Tips und Anleitungen (SP50047) a/f Faxanfrage erhältlich.

Dicas e Técnicas (SP50047) disponíveis via pedido por fax.
提示與方法 (SP50047) 可以通過電傳獲得

1
Trim cable jacket.
Recortar la envuelta del cable.
Coupez la gaine du câble.
Kabelmantel abziehen.
Retire a capa do cabo.
切整電纜外皮

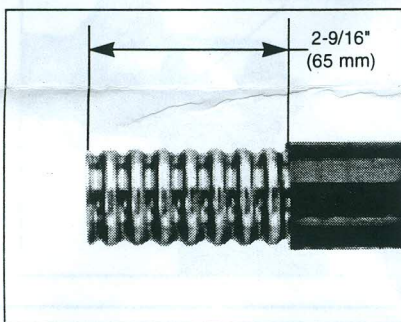

2
Add O-ring, grease, and clamping nut.
Añadir la junta tórica, la grasa y la tuerca sujetadora.
Mettez en place le joint torique, de la graisse et l'écrou de serrage.
O-Ring und Klemmutter vor Montage einfetten.
Coloque o anel O ring, graxa e a porca de aperto.
加 O 型圈，油脂和緊固螺母

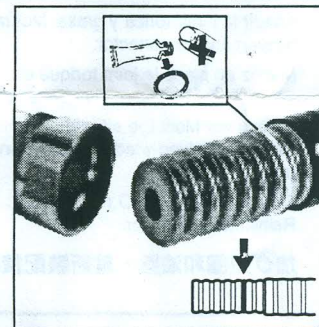

3
Close plastic clamp around the clamping nut as shown.
Cerrar la sujeción de plástico alrededor de la tuerca sujetadora como se muestra en la figura.
Fixez l'attache en plastique autour de l'écrou de serrage, comme illustré.
Kunststoffklammer wie gezeigt um die Klemmutter legen und schließen.
Feche abraçadeira de plástico em volta da porca de aperto, conforme mostrado.
如圖所示將塑料卡子合卡在卡緊螺母周圍。

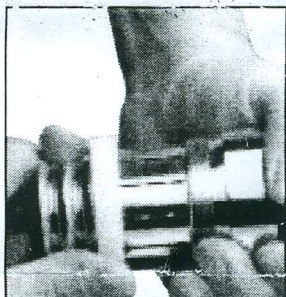

4
Cut cable.
Cortar el cable.
Coupez le câble.
Kabel abschneiden.
Corte o cabo.
切割電纜

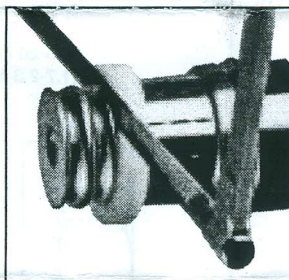

5
Remove burrs and debris.
Quitar virutas. Retirar los restos.
Ebavurez. Enlevez les débris.
Entgraten. Metallspäne entfernen.
Remove rebarba. Remova os detritos.
去除毛口去除殘渣

